

# Purity<sup>TM</sup>

POLY CRYSTALLINE

CERAMIC BRACKETS

by Modern Orthodontics

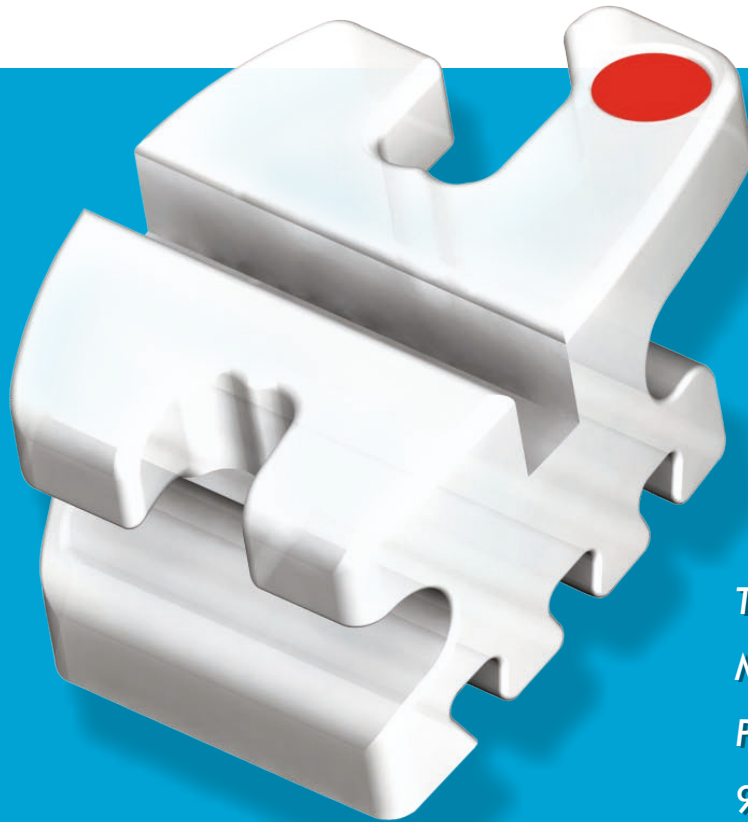

Translucent  
Micro Crack Free  
Pure Mechanical Bonding  
99.99% Pure Alumina

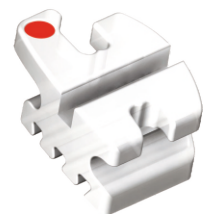

Compare to  
Illusion Plus<sup>TM</sup> by Ortho Organizers  
Eclipse<sup>TM</sup> by Masel, Reflections<sup>TM</sup> by Ortho Technology

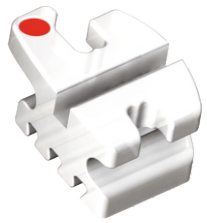

Purity™  
POLY CRYSTALLINE  
CERAMIC BRACKET SYSTEM

Purity™  
Poly-Crystalline  
CERAMIC BRACKET SYSTEM

Compare to  
Illusion Plus™ by Ortho Organizers  
Eclipse™ by Masel, Reflections™ by Ortho Technology

*Dove Tail Grooves*  
for pure  
mechanical bonding

*99.99% Pure Alumina*  
Extremely resistant to slot wear  
cracking and fracturing

*Translucent*  
for pleasing aesthetics  
Disappears on the tooth

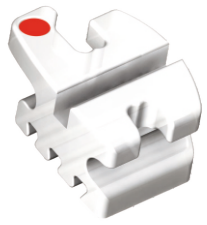

Purity™  
POLY CRYSTALLINE  
CERAMIC BRACKET SYSTEM

Removable Color Coded ID Dot  
For easy bracket selection

Ultra-Smooth, Strong Hooks  
For added patient comfort and  
secure engagement of elastics

Smooth, Strong and  
Contoured Tie Wings  
For added patient comfort

Ample Tie Wing Area  
For easy bracket ligation

Archwire Slot Design  
Resists deformation and less friction  
for superior sliding mechanics

Dovetail Bonding Base  
Provides superior mechanical bond  
strength and predictable debonding

Compound Contour Base  
Provides simplified and accurate  
bracket placement

Highest Quality Material  
Made from high quality poly  
urethane composite

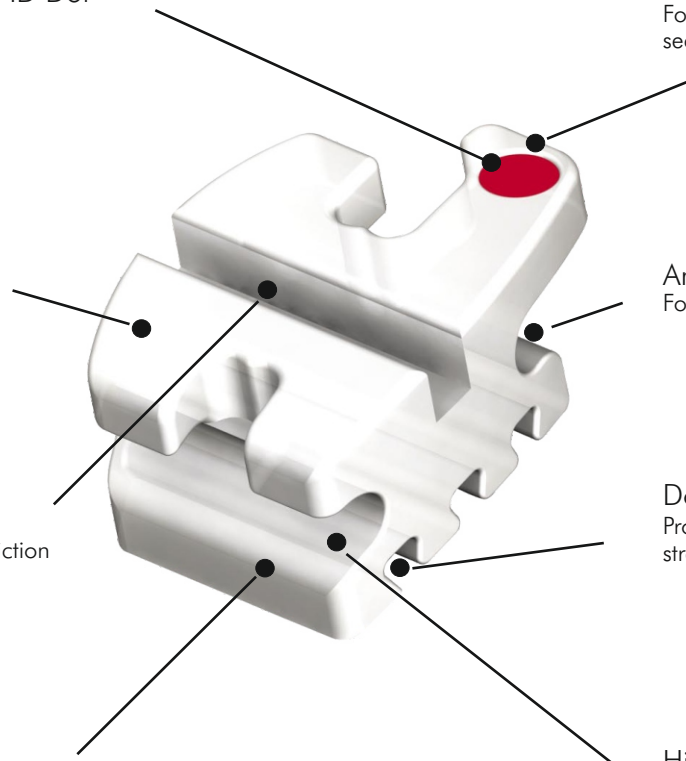

Compare to  
Illusion Plus™ by Ortho Organizers  
Eclipse™ by Masel, Reflections™ by Ortho Technology



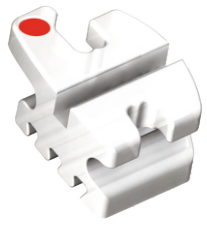

Purity™  
POLY CRYSTALLINE  
CERAMIC BRACKET SYSTEM

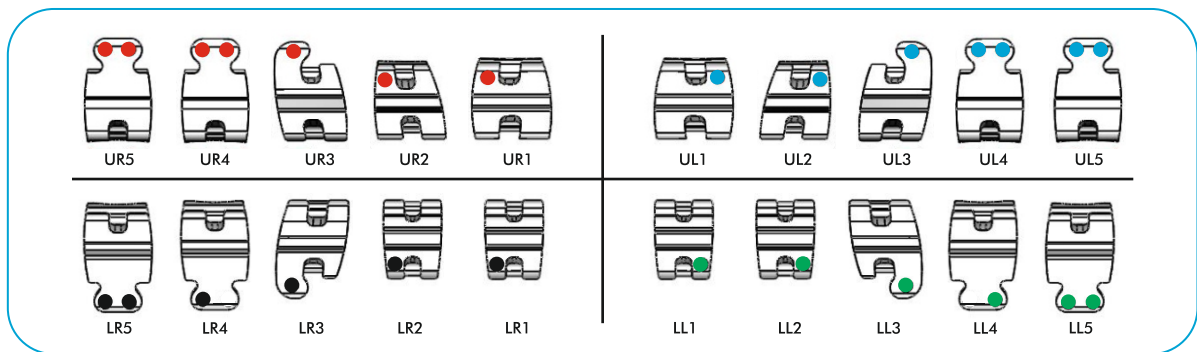

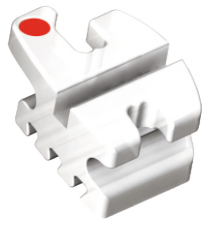

Purity™  
POLY CRYSTALLINE  
CERAMIC BRACKET SYSTEM

## Bonds & De-Bonds Just Like A Metal Bracket



De-bonding tool to be used



Grasp the brackets on the mesio-distal side close to the tooth



Wrong method of De-bonding

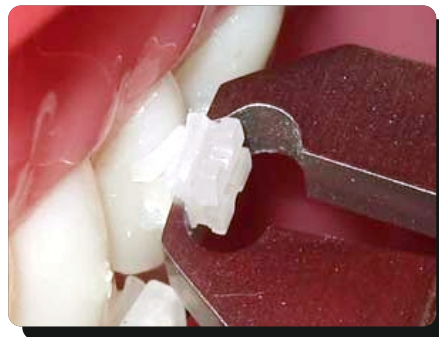

Twist the bracket 90° clockwise to safely remove the bracket

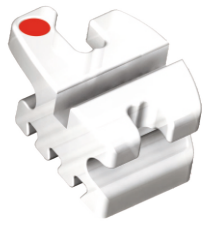

Purity™  
POLY CRYSTALLINE  
CERAMIC BRACKET SYSTEM

Roth Prescription

Maxillary ▲

	Tooth	Torque	Angle	Width	R/L	ID	.018	.022
1 1	Central	+12°	+5°	.155"	R	●	BTP-R8-001	BTP-R2-001
					L	●	BTP-R8-002	BTP-R2-002
2 2	Lateral	+8°	+9°	.133"	R	●	BTP-R8-003	BTP-R2-003
					L	●	BTP-R8-004	BTP-R2-004
3 3	Cuspid with Hook	0°	+11°	.131"	R	●	BTP-R8-005	BTP-R2-005
					L	●	BTP-R8-006	BTP-R2-006
4/5 4/5	1st & 2nd Bicuspid	-7°	0°	.130"	R	●	BTP-R8-009	BTP-R2-009
					L	●	BTP-R8-010	BTP-R2-010
4/5 4/5	1st & 2nd Bicuspid Hk	-7°	0°	.130"	R	●	BTP-R8-011	BTP-R2-011
					L	●	BTP-R8-012	BTP-R2-012

Roth Prescription

Mandibular ▼

	Tooth	Torque	Angle	Width	R/L	ID	.018	.022
1/2 1/2	Lower Anterior	0°	0°	.110"	R	●	BTP-R8-014	BTP-R2-014
					L	●	BTP-R8-015	BTP-R2-015
3 3	Cuspid With hook	-11°	+5°	.133"	R	●	BTP-R8-016	BTP-R2-016
					L	●	BTP-R8-017	BTP-R2-017
4 4	1st Bicuspid	-17°	0°	.133"	R	●	BTP-R8-020	BTP-R2-020
					L	●	BTP-R8-021	BTP-R2-021
4 4	1st Bicuspid with hook	-17°	0°	.133"	R	●	BTP-R8-022	BTP-R2-022
					L	●	BTP-R8-023	BTP-R2-023
5 5	2nd Bicuspid	-22°	0°	.133"	R	●	BTP-R8-024	BTP-R2-024
					L	●	BTP-R8-025	BTP-R2-025
5 5	2nd Bicuspid with hook	-22°	0°	.133"	R	●	BTP-R8-026	BTP-R2-026
					L	●	BTP-R8-027	BTP-R2-027

Full Kits ▲▼

Kits	.018	.022
Upper/Lower 5x5 Hook on 3	BKP-R8-102	BKP-R2-102
Upper/Lower 5x5 Hooks on 3,4 & 5	BKP-R8-104	BKP-R2-104

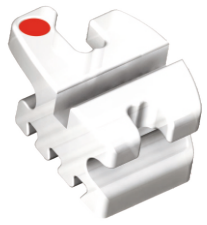

MBT Prescription  
Maxillary ▲

	Tooth	Torque	Angle	Width	R/L	ID	.018	.022
1 1	Central	+17°	+4°	.125"	R	●	BTP-M8-101	BTP-M2-101
					L	●	BTP-M8-102	BTP-M2-102
2 2	Lateral	+10°	+8°	.122"	R	●	BTP-M8-103	BTP-M2-103
					L	●	BTP-M8-104	BTP-M2-104
3 3	Cuspid with hook	0°	+9°	.122"	R	●	BTP-M8-105	BTP-M2-105
					L	●	BTP-M8-106	BTP-M2-106
3 3	Cuspid with hook	-7°	+9°	.122"	R	●	BTP-M8-107	BTP-M2-107
					L	●	BTP-M8-108	BTP-M2-108
4/5 4/5	1 <sup>st</sup> & 2 <sup>nd</sup> Bicuspid	-7°	0°	.122"	R	●	BTP-M8-109	BTP-M2-109
					L	●	BTP-M8-110	BTP-M2-110
4/5 4/5	1 <sup>st</sup> & 2 <sup>nd</sup> Bicuspid Hk	-7°	0°	.122"	R	●	BTP-M8-111	BTP-M2-111
					L	●	BTP-M8-112	BTP-M2-112

MBT Prescription  
Mandibular ▼

	Tooth	Torque	Angle	Width	R/L	ID	.018	.022
1/2 1/2	Lower Anterior	-6°	0°	.116"	R	●	BTP-M8-114	BTP-M2-114
					L	●	BTP-M8-115	BTP-M2-115
3 3	Cuspid with hook	0°	+3°	.122"	R	●	BTP-M8-116	BTP-M2-116
					L	●	BTP-M8-117	BTP-M2-117
3 3	Cuspid with hook	-6°	+3°	.122"	R	●	BTP-M8-118	BTP-M2-118
					L	●	BTP-M8-119	BTP-M2-119
4 4	1 <sup>st</sup> Bicuspid	-12°	+2°	.122"	R	●	BTP-M8-120	BTP-M2-120
					L	●	BTP-M8-121	BTP-M2-121
4 4	1 <sup>st</sup> Bicuspid with hook	-12°	+2°	.122"	R	●	BTP-M8-122	BTP-M2-122
					L	●	BTP-M8-123	BTP-M2-123
5 5	2 <sup>nd</sup> Bicuspid	-17°	+2°	.122"	R	●	BTP-M8-124	BTP-M2-124
					L	●	BTP-M8-125	BTP-M2-125
5 5	2 <sup>nd</sup> Bicuspid with hook	-17°	+2°	.122"	R	●	BTP-M8-126	BTP-M2-126
					L	●	BTP-M8-127	BTP-M2-127

Full Kits ▲▼

Kits	.018	.022
Upper/Lower 5x5 Hook on 3	BKP-M8-102*	BKP-M2-102*
Upper/Lower 5x5 Hooks on 3,4 & 5	BKP-M8-104*	BKP-M2-104*
Upper/Lower 5x5 Hook on 3	BKP-M8-202	BKP-M2-202
Upper/Lower 5x5 Hooks on 3,4 & 5	BKP-M8-204	BKP-M2-204

\* Cuspid brackets in these Kits are having -7 deg torque in uppers and -6 deg torque in lowers.  
Other kits have 0 deg torque in all cuspids.  
For any other cuspid torque combination, please place order for individual brackets.

# Purity™

CERAMIC BRACKET SYSTEM



# Purity™

CERAMIC BRACKET SYSTEM



# Purity™

Poly-Crystalline

CERAMIC BRACKET SYSTEM

by Modern Orthodontics LLC

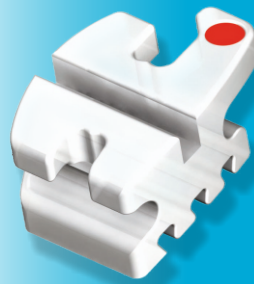

Modern  
Orthodontics

